

TOGGLES AND PANELS: LUX

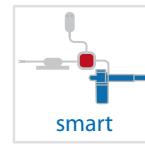
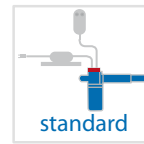

MAIN FEATURES

- Buttons: UP to 5
- Housing colour: Chromed finish
- Buttons and frame colour: Chromed finish

OPTIONALS

- 1 - Reset function: Operate simultaneously 2 motors to reach zero position
- 2 - Battery charger
- 3 - Battery status panel
- 4 - USB charger (2A)
- 5 - Backlight

TECHNICAL DATA:

- Protection type: IP20
- Material: ABS
- Supply Voltage: 5÷30Vdc

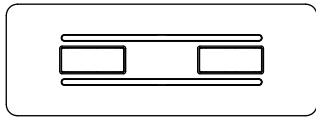

Single / Dual motors

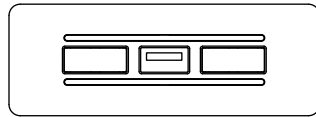

Single / Dual motors
+USB charger

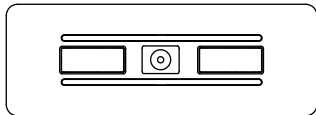

Single / Dual motors
+Battery status panel
+Battery charger plug

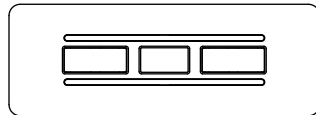

Single / Dual motors
+Reset button

DIMENSIONS

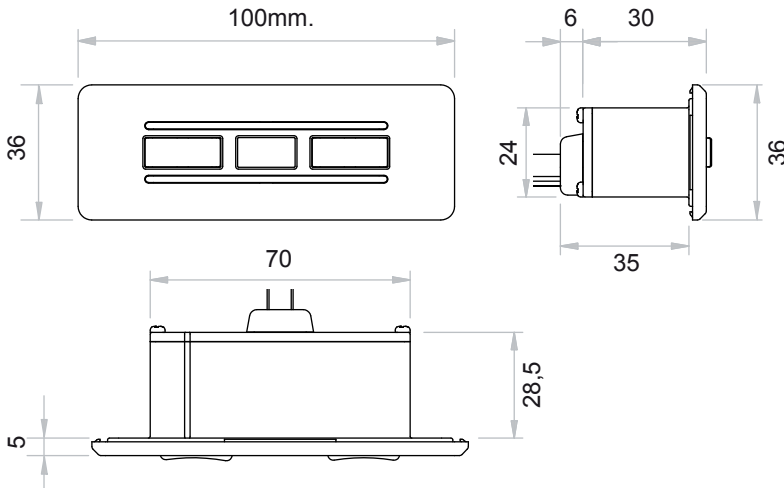

Convex Button
for Single motor



Concave Button
for Dual motors



Backlight leds

STANDARD 1 MOTOR KIT CONFIGURATION

